



Necesario uso de llave fija del n° 10  
Nécessaire utilisation d'une clef plate de 10  
Verwendung Schraubenschlüssel Nr.10 notwendig



Se recomienda el uso de guantes  
Nous recommandons l'utilisation de gants  
Verwendung von Handschuhen wird empfohlen

### 400 mm

FONDO - PROFONDEUR - TIEFE

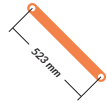
H (mm)		
1950	3	3
2550	3	5
3000	3	6

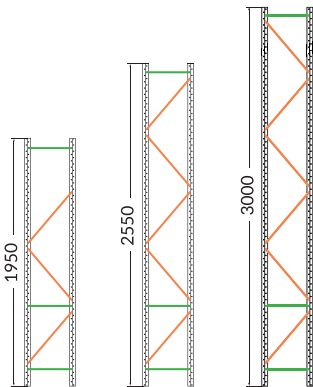
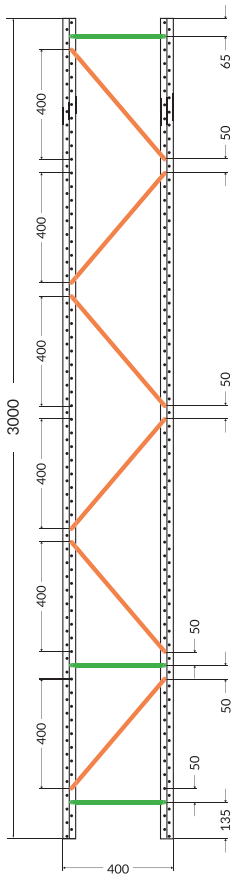

### 600 mm

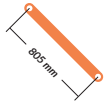

FONDO - PROFONDEUR - TIEFE

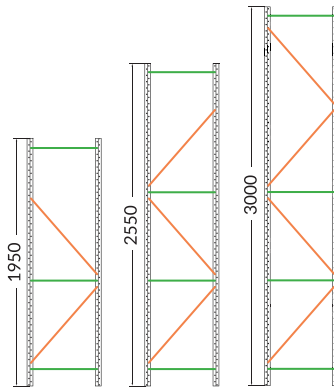
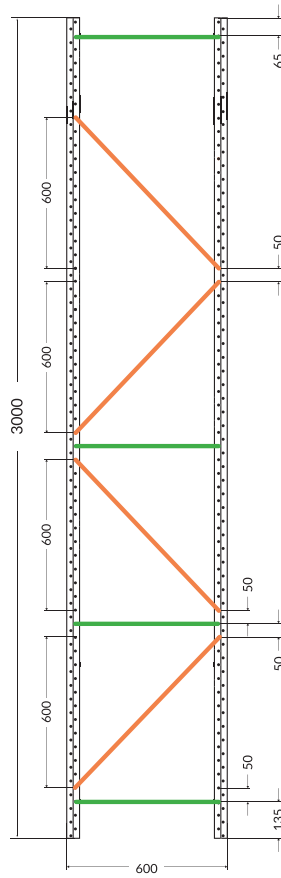
H (mm)		
1950	3	2
2550	4	3
3000	4	4



### 800 & 1000 mm

FONDO - PROFONDEUR - TIEFE

H (mm)		
1950	3	2
2550	4	3
3000	4	3

